

# Rockfon<sup>®</sup> Planostile<sup>™</sup> D Three Dimensional Panels

## Features & Benefits

- Lay-in metal panels with variable deep recess or reveal options for creation of 3-dimensional interior grid based installation
- Range of recessed, reveal edge, sloped, and diagonal panels in depths of 1" to 4"
- Acoustical performance options available

## Applications

- Conference Rooms
- Lobbies
- Airport Terminals
- Transit Facilities
- Retail



# Rockfon® Planostile™ D

## Three Dimensional Panels

### LEED® v4.1 Highlights

#### Materials and Resources (MR)

- Waste Management Planning ✓
- Interiors Life Cycle Impact Reduction ✓
- Environmental Product Declarations ✓
- Sourcing of Raw Materials ✓
- Material Ingredients -
- Waste Management ✓

#### Indoor Environmental Quality (EQ)

- Low-Emitting Materials ✓
- Interior Lighting -
- Acoustic Performance ✓

**Recycled Content:** 85% Aluminum  
30% Steel

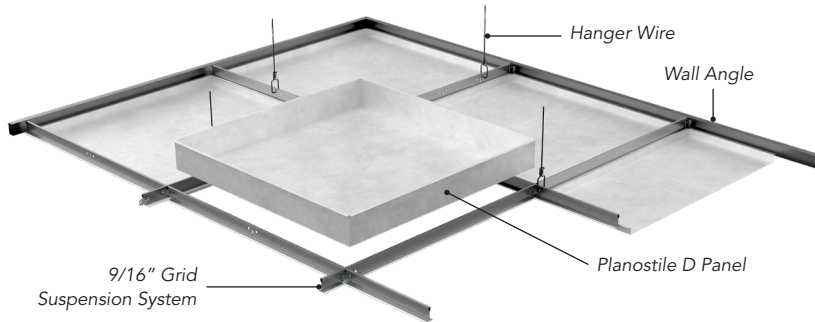

Family Number & Name	Panel Profile	Dimensions	Perforations (% Open Area)	Material	NRC	Fire Class	Low VOC	Recycled Content
Planostile D Reveal Edge 252588:PLAD		<b>2' x 2'</b> 1" x 1" up/down	<b>Standard Perforations</b> <b>AA:</b> 2.5% Open <b>D:</b> 16.2% Open <b>E:</b> 20.8% Open	0.040 Aluminum	Up to .90*	A	✓	85%
Planostile D Sloped 252588:PLDS		2" x 2" up/down 3" x 3" up/down						
Planostile D Diagonal 252588:PLDD		4" x 4" up/down						

Product Code Example:

**252588PLST:PLAD:24x24:.040:44:E:Y**

Family Number	Panel Size	Material	Finish	Perforation
<b>252588:PLAN</b>	<b>24"x24"</b>	<b>40</b>	<b>44</b>	<b>E</b>
Planostile D Reveal		.040 Aluminum	Satin Silver	Perforation E with Acutex

\*NRC values are dependent on the acoustical backer options available.  
Acutex backer standard on perforated panels. Panels install on standard 9/16" face grid system.  
**Note: This system is not approved for exterior use**

# Planostile™ D Color Chart

## Standard Colors:



01  
White



08  
Black



44  
Satin Silver



888  
Winchester  
Grey

## Premium Colors:



Color-All



Custom  
(Color Match)

## Metalwood® Solid Coordinating Colors:



401  
Maple\*



402  
Oak\*



403  
Cherry\*



404  
Pumpkin  
Maple\*



405  
Karri\*



406  
Walnut\*

\* Metalwood Woodgrain Finishes unavailable on Planostile D products; use coordinating solid finish.

Note:

- See [rockfon.com](http://rockfon.com) for more information on color options.

Colors shown are reproduced as close as possible to actual product color within the limitations of printing technology. Color chips are available upon request and should be reviewed before making a final selection. Variations in color matches of system components to ceiling panels can result from slight differences in texture, room lighting, painting process and subjectivity of observers.

# Rockfon® Planostile™ D

## Perforation Options

### Standard Perforation Options

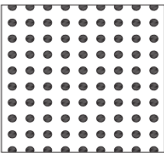

**D**  
 98R216L  
 0.098" Diameter holes  
 0.216" Staggered centers  
 16.2% Open area

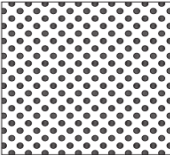

**E**  
 71R138D  
 0.071" Diameter holes  
 0.138" Staggered centers  
 20.8% Open area

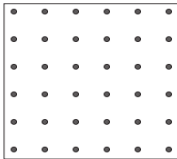

**AA**  
 62R354L  
 0.0625" Diameter holes  
 0.354" Staggered centers  
 2.5% Open area

### Acoustical Performance

Planostile D Panels	NRC
With Acoutex Backer	0.70
With 1.5" x 1.5 lb insulation	0.90

Custom perforation options are available. Please contact [estimating@rockfon.com](mailto:estimating@rockfon.com) for information.

# Rockfon® Planostile™ D

## Suspension System



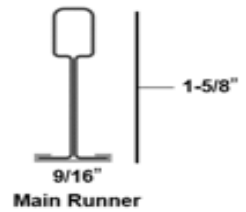
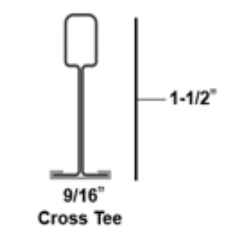

### 9/16" Face Grid Suspension

	Product Number	Duty Rating	Length	Slotting	Spacing
<b>Main Runners</b>					
 <p>9/16" Main Runner</p>	10.04.000.xxx	ID	144"	6" on Center	48" on Center
	10.04.040.xxx	HD	144"	6" on Center	48" on Center
<b>Cross Tees</b>					
 <p>9/16" Cross Tee</p>	10.04.014.xxx	N/A	48"	12" on Center	24" on Center
	10.04.022.xxx	N/A	24"	No Slots	24" on Center

Duty rating applies only to main runners installed on a 4' span.  
 Suspension system for Planostile based on Chicago Metallic® Ceiling Suspension Systems.  
 See ICC /ESR-2631 for component testing information.  
 For seismic installations, please refer to the Rockfon Seismic Ceiling Suspension Guide.

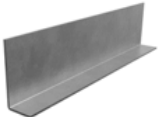
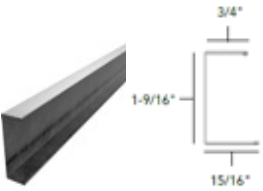
# Rockfon® Planostile™ D

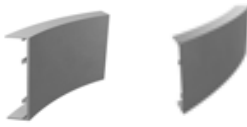
## Perimeter Components

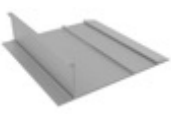
	Product	Dimensions	Length	Height	Packaging
<b>Wall Angle</b>					
	38.90.124.xxx	3/4" x 15/16"	144"	-	300 ft per Carton
	C3228.xx	1" x 2"	144"	-	Sold per Piece
<b>Wall Channel</b>					
	60.00.011.xxx	3/4" x 1-9/16" x 15/16"	10'	-	Sold per Piece
Perimeter Trim	Product	Part Number	Length	Height	Packaging
	Engineered Straight	252565 / INFE:STD	12' Max	4", 6", 8", 10", 12"	As Needed
	Engineered Curved	252566 / INFC:STD	12' Max	4", 6", 8", 10", 12"	As Needed
	Infinity R Reveal Edge	252565 / INFE:REV	12' Max	4"	As Needed
	Infinity Z Razor Edge	252565 / INFE:RAZ	12' Max	2" high 6" flange	As Needed

# Rockfon® Planostile™ D

## Accessories

### Acoustical Pads - Black Vinyl Wrapped

	Description	Catalog Number	Rockfon Reference Number
	2' x 2' Poly-Wrapped Acoustical Pad 1" x 1#	58.01.059.008	250505
	2' x 4' Poly-Wrapped Acoustical Pad 1" x 1#	58.01.061.008	250507
	2' x 2' Poly-Wrapped Acoustical Pad 1.5" x 1#	58.01.064.008	250509
	2' x 4' Poly-Wrapped Acoustical Pad 1.5" x 1#	58.01.063.008	250508

### Additional Accessories

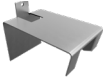
	Description	Catalog Number	Rockfon Reference Number
	Aluminum Hold Down for 1-9/16" Channel 11"	60.00.013	249674
	Aluminum Hold Down for 1-9/16" Channel 22"	60.00.015	249675
	Seismic Perimeter Clip	1496.00	250374
	Perimeter Clip	1499.00	251952
	Hold Down Clip (1" Panels) - Black Metal	63.26.200	264683
	Clear Plastic Hold Down Clips - 100 Pcs. per Ctn. (For 1" Panels Only)	8886.00	250382

# Rockfon® Planostile™ D

## Panel Options

---



Reveal Edge Panel - Upward or Downward



Sloped Panel - Upward or Downward

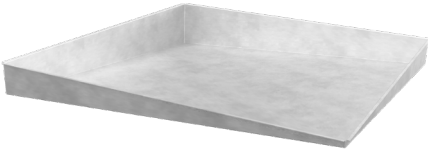

Diagonal Panel - Upward or Downward

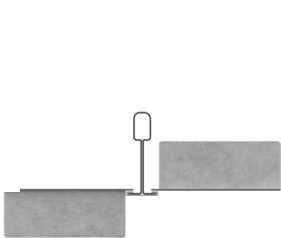

1" Up or Down

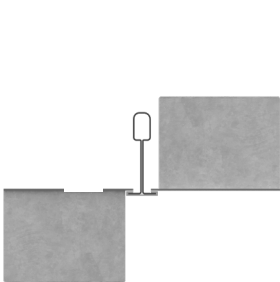

2" Up or Down

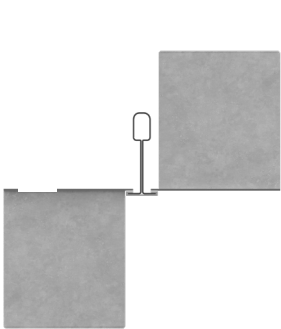

3" Up or Down

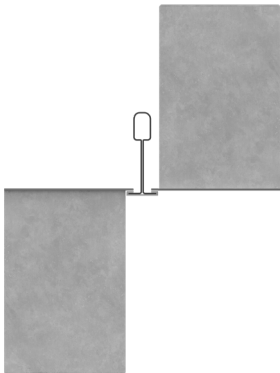

4" Up or Down





## Rockfon® Planostile™ D

### Material

0.040" Aluminum



#### Fire Performance

Surface burning characteristics:  
UL723 (ASTM E84) Flame Spread Index: 0  
Smoke Developed Index (UL Labeled): 0



#### Environment

85% recycled content  
100% locally recyclable



#### Warranty

1-Year Limited Product Warranty  
See [rockfon.com](http://rockfon.com)



#### Hygiene

Metal provides no sustenance  
to microorganisms



#### Cleaning

Damp cloth

091322

### Rockfon

4849 S. Austin Ave.  
Chicago, IL 60638 USA